

USB to I²C trimming interface board with embedded load for automatic power supply trimming based on the SEA01

Data brief

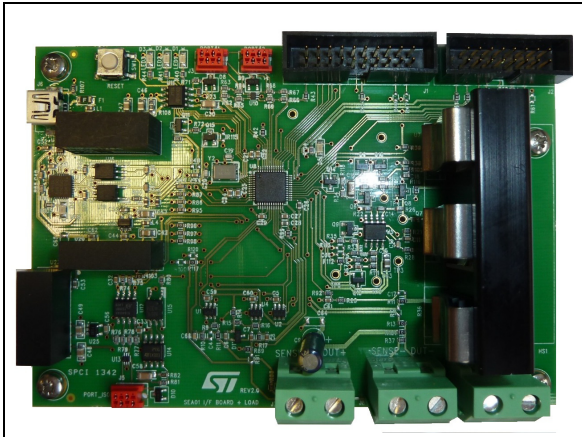

- Three I²C buses running at 100 kHz, including one which is electrically isolated from the active load
- Integrated electronic active load with sink capabilities of up to 25 V / 10 A
- Self-calibrated references
- Voltage and current measurement with precision of 0.1% (voltage) and 1% (current)
- Integrated temperature sensor to monitor on-board load temperature
- RoHS compliant

Features

- Bidirectional communication between PC (USB) and SEA01 (I²C)
- Self-powered from the USB line
- On-board 19 V generation for SEA01 programming
- Electrical isolation between USB and the other circuitry on the board

1 Description

The STEVAL-PCC019V1 is an evaluation tool used to interface a Windows[®]-based PC with digitally trimmable products like the SEA01 constant voltage and current controller with online digital trimming from STMicroelectronics. It functions basically as a bidirectional bridge between USB and I²C buses. The board also embeds an active CC/CV load to trim SEA01-based power supplies without the need for external instruments (such as supply, voltmeter, active load).

The STEVAL-PCC019V1 is self-supplied via the 5 V from the USB connector.

Three isolated DC-DC modules are used to provide the correct supplies to the remaining parts of the board, maintaining the isolation between the PC and target sides.

The board is also capable of providing the target device (SEA01) with a V_{CC} voltage high enough to program NVM (in cases where the supply is < 17 V).

Communication between the STEVAL-PCC019V1 and the PC is managed by a standard serial peripheral, converting the USB connection into a virtual COM port.

The RX and TX signals are then isolated using opto-couplers and connected to the STM32 microcontroller, ensuring that the USB port and the remaining parts of the board are isolated from the mains.

The microcontroller is the heart of the system, and it is in charge of performing conversion between the UART and I²C protocols. The STM32 manages the UART to I²C conversion allowing bidirectional communication between the PC and the target device.

The I²C speed is set to 100 KHz (the maximum speed allowed by the SEA01).

In order to fulfill all possible SEA01 application needs, the board embeds three I²C ports, one of which is also isolated from the 2 others (depending on whether the SEA01 is put on primary or secondary). This allows trimming of the SEA01 in various configurations (primary, secondary side), or even multiple SEA01 chips.

A companion evaluation board (STEVAL-ISA161V1) which includes the SEA01 as secondary side CV/CC controller can be interfaced with the STEVAL-PCC019V1 to test the benefits of digital trimming in a real application.

2 GUI features

The main purpose of the associated GUI is to perform trimming operations for the SEA01 to a desired setting point (both voltage and current limitation). Trimming parameters can be read, and also changed, on the fly.

In addition, in a second step the GUI can also be used to manually verify the trimming calibration by operating the supply in CC or CV mode, without any external instruments.

Figure 1. GUI main panel

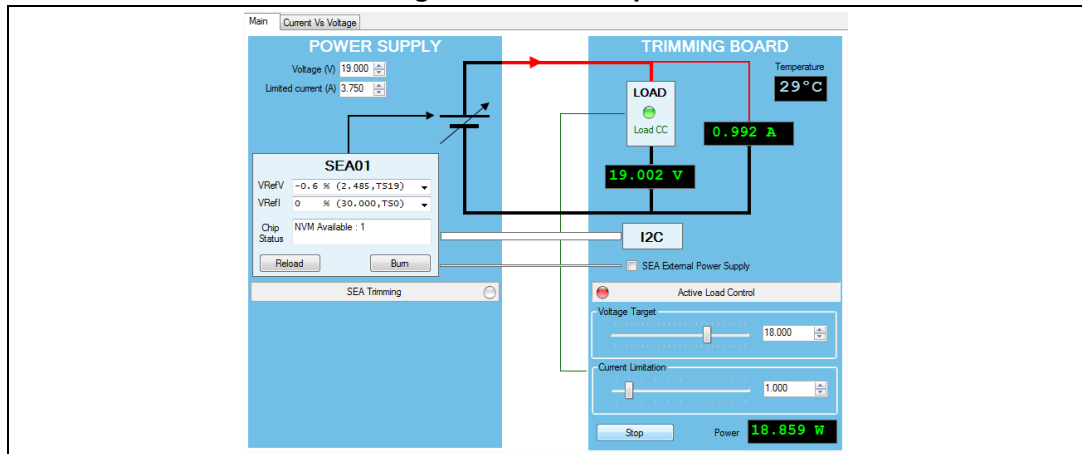

Another interesting feature of the GUI is the embedded characteristic curve tracer.

This allows the display of the power supply behavior almost instantaneously by simply pressing a button. Both CC and CV modes of operation are supported.

Figure 2. GUI curve tracer

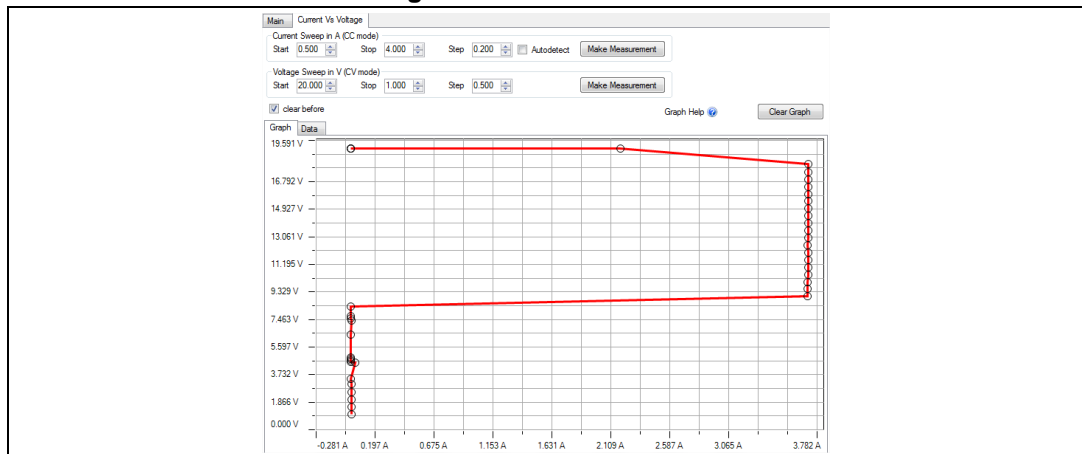

Because on-board heatsink is relatively small, its temperature is also monitored to protect the load.

Figure 4. STEVAL-PCC019V1 circuit schematic (2 of 6)

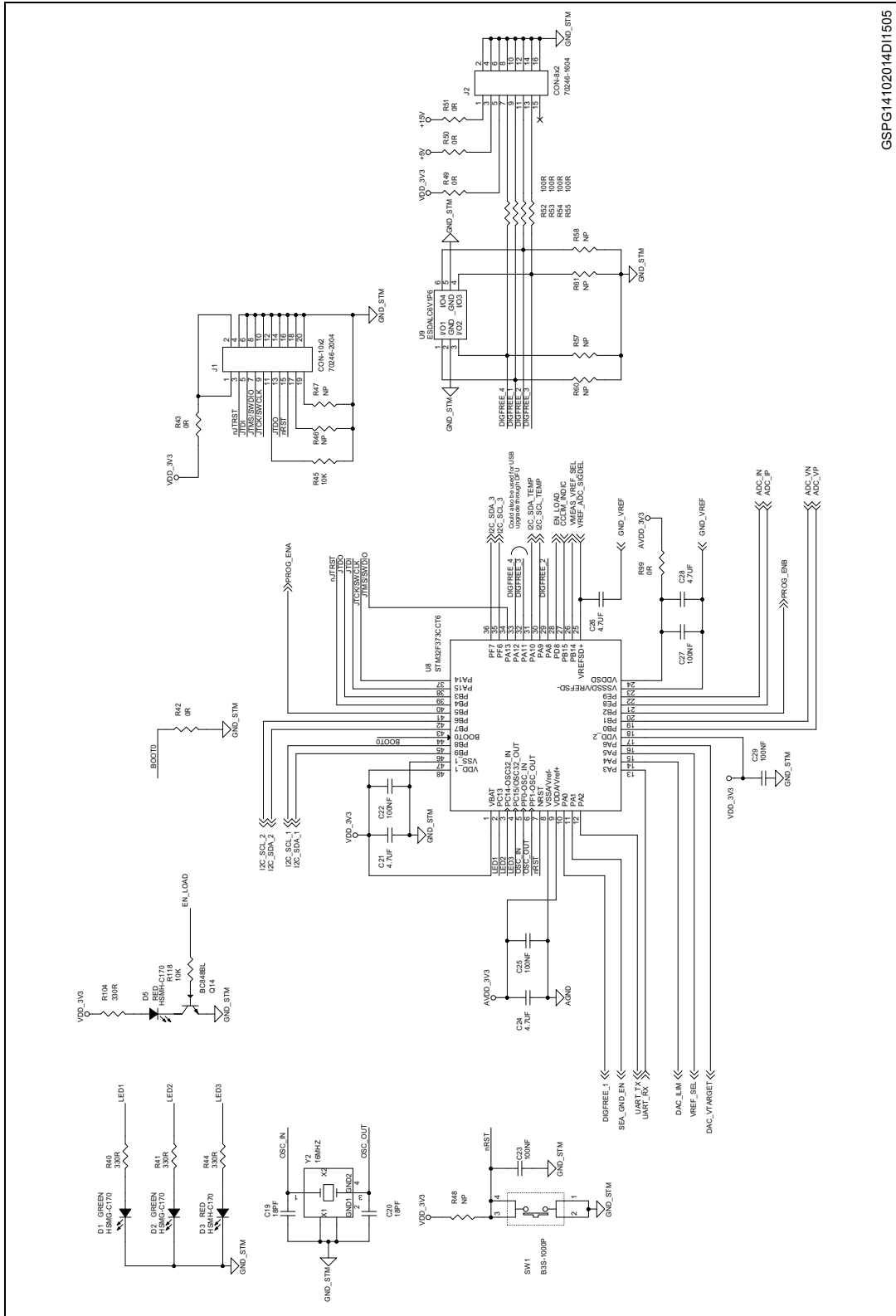

CGSPG14102014DJ1505



Figure 5. STEVAL-PCC019V1 circuit schematic (3 of 6)

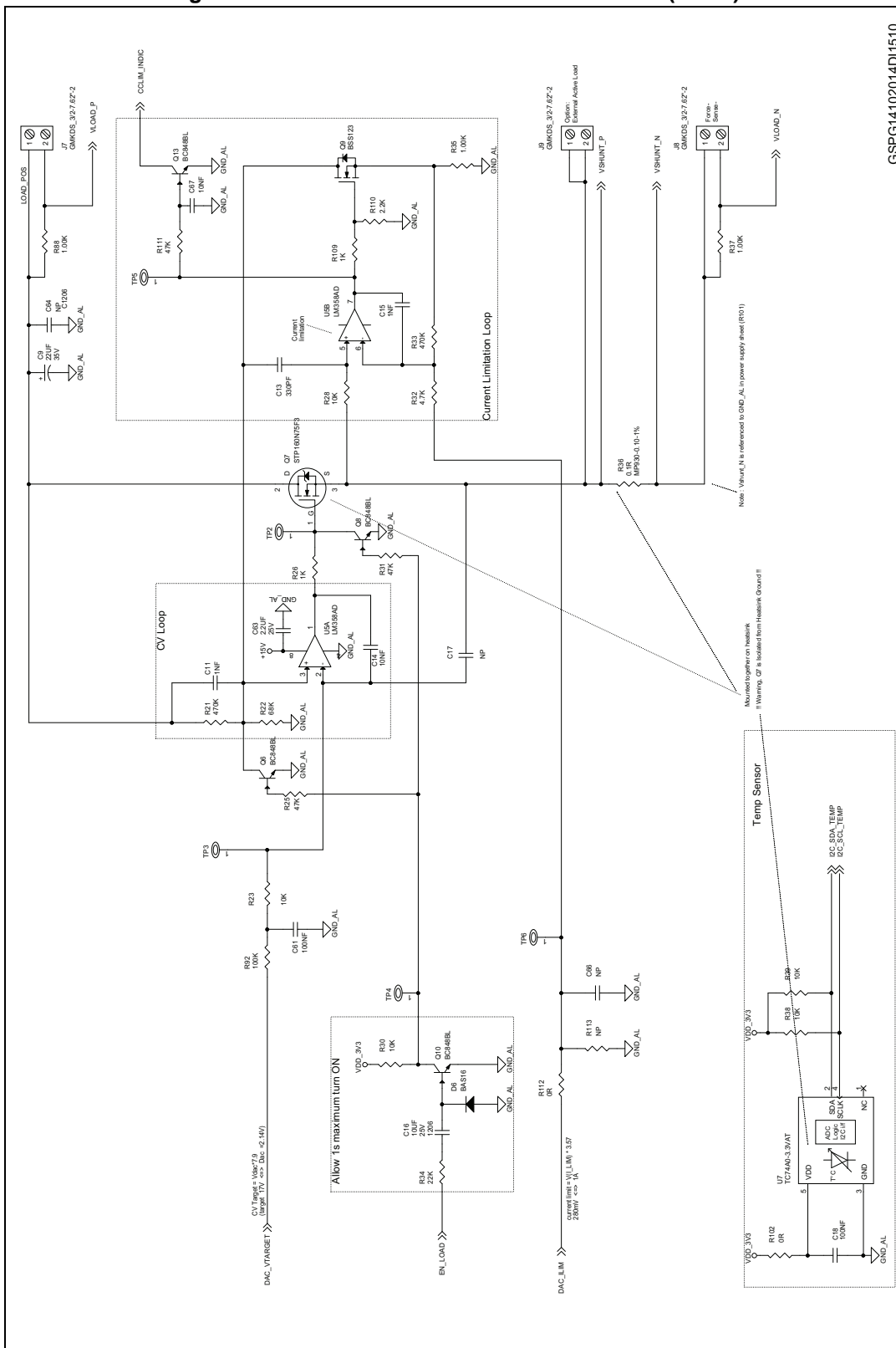

GSPG14102014D1510



Figure 6. STEVAL-PCC019V1 circuit schematic (4 of 6)

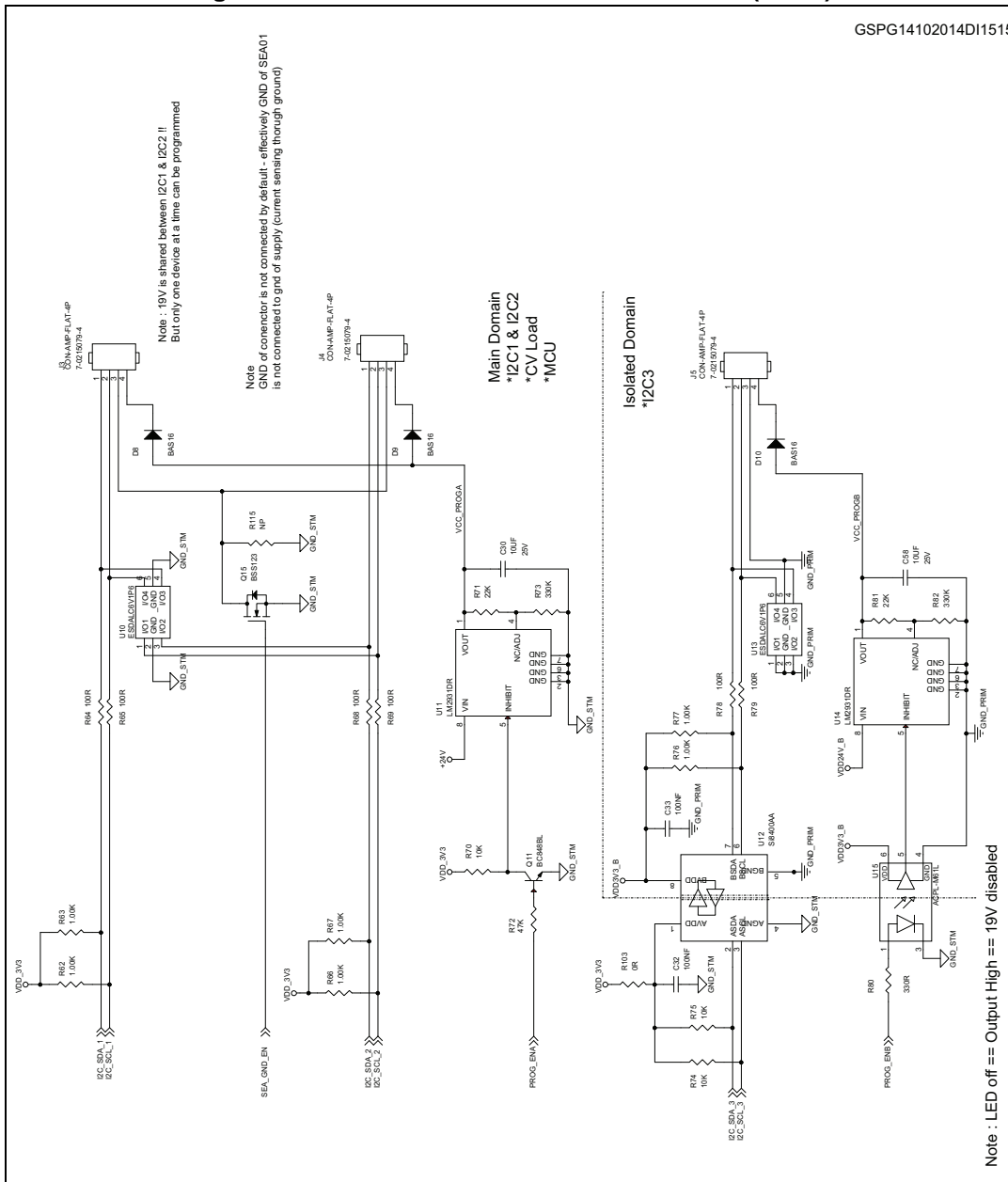

GSPG14102014DI1515

Figure 7. STEVAL-PCC019V1 circuit schematic (5 of 6)

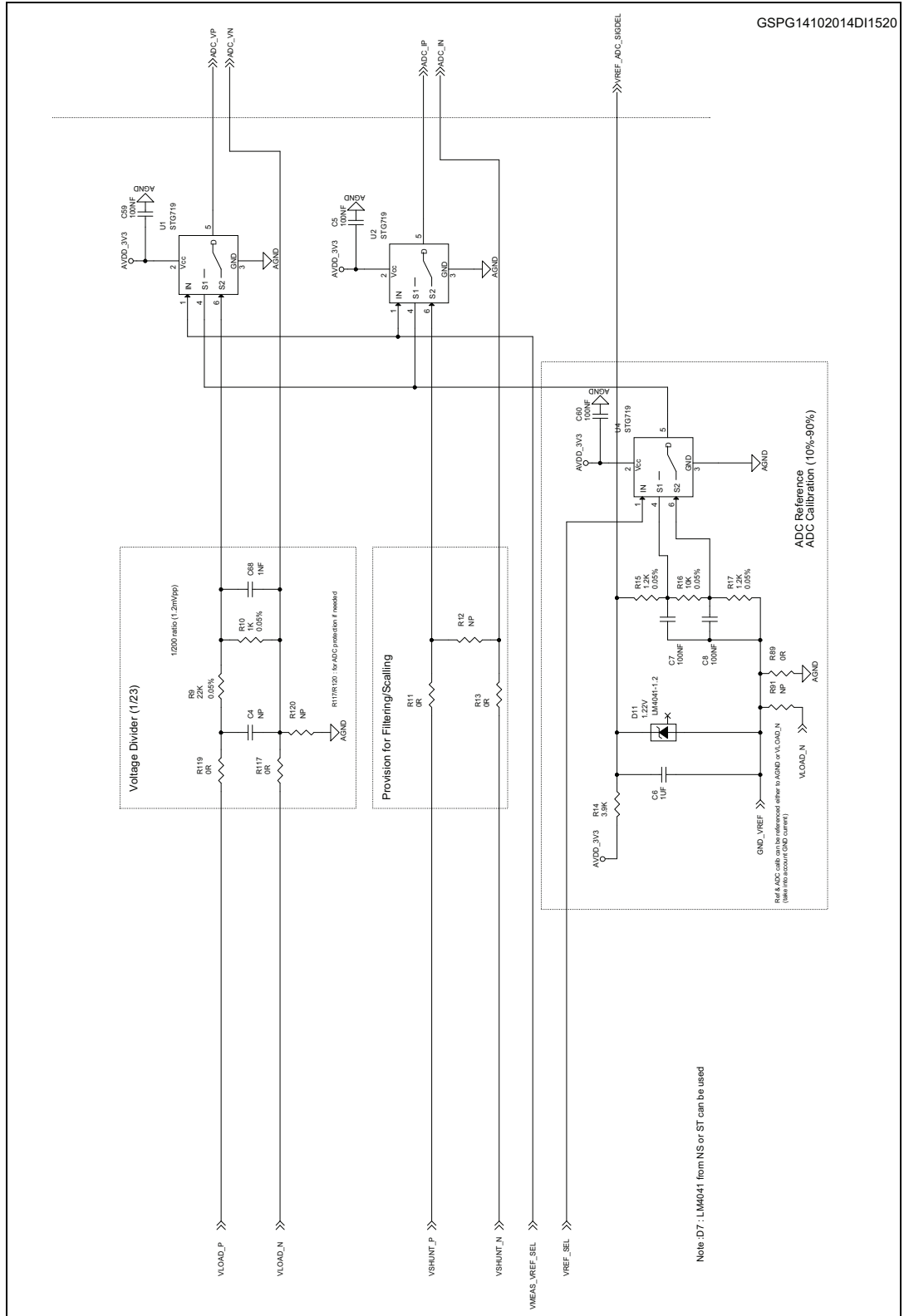
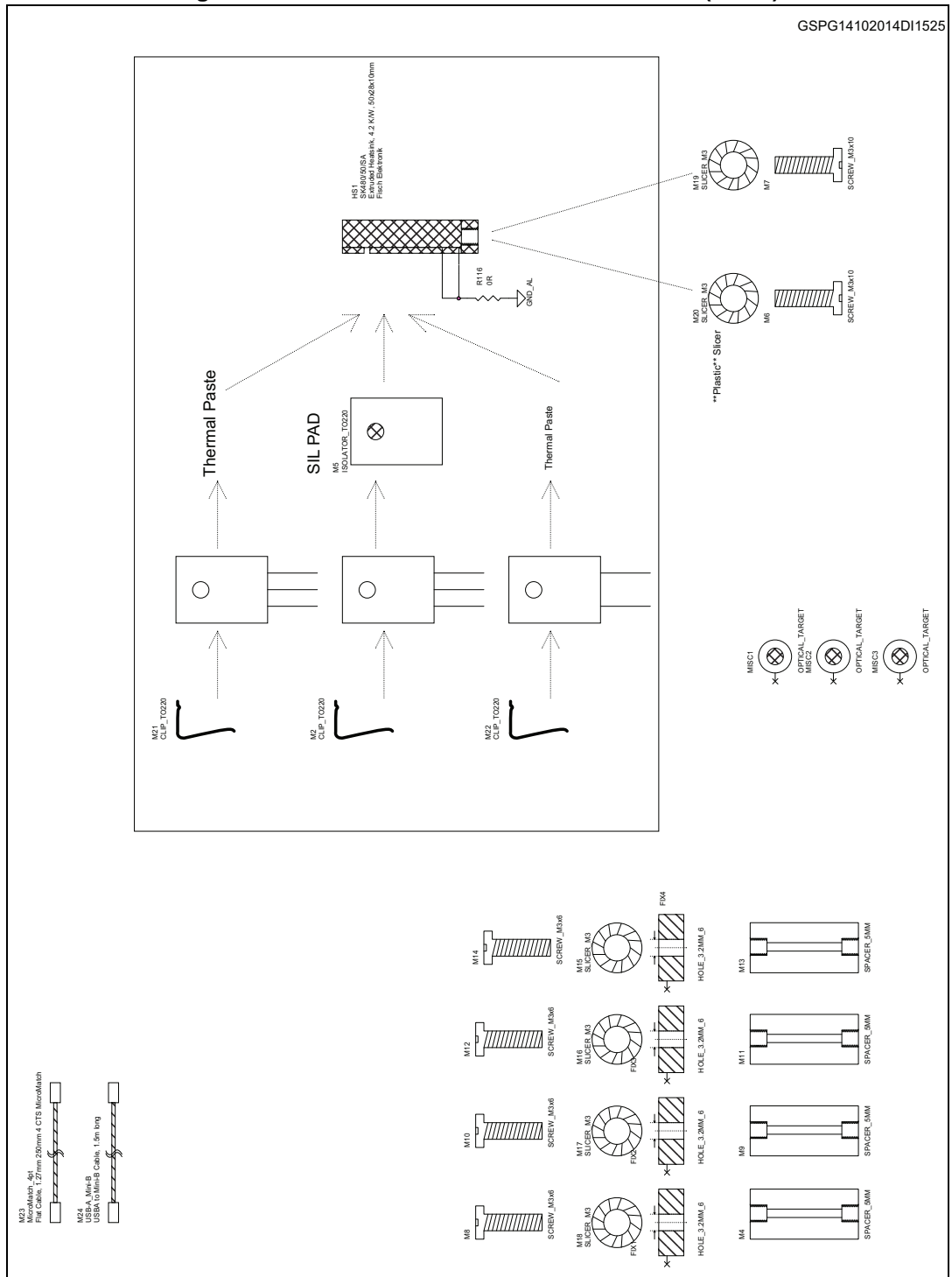

Figure 8. STEVAL-PCC019V1 circuit schematic (6 of 6)



4 Revision history

Table 1. Document revision history

Date	Revision	Changes
22-Oct-2014	1	Initial release.

IMPORTANT NOTICE – PLEASE READ CAREFULLY

STMicroelectronics NV and its subsidiaries ("ST") reserve the right to make changes, corrections, enhancements, modifications, and improvements to ST products and/or to this document at any time without notice. Purchasers should obtain the latest relevant information on ST products before placing orders. ST products are sold pursuant to ST's terms and conditions of sale in place at the time of order acknowledgement.

Purchasers are solely responsible for the choice, selection, and use of ST products and ST assumes no liability for application assistance or the design of Purchasers' products.

No license, express or implied, to any intellectual property right is granted by ST herein.

Resale of ST products with provisions different from the information set forth herein shall void any warranty granted by ST for such product.

ST and the ST logo are trademarks of ST. All other product or service names are the property of their respective owners.

Information in this document supersedes and replaces information previously supplied in any prior versions of this document.

© 2014 STMicroelectronics – All rights reserved

